



JAPANESE CAR BRAKE APPLICATIONS

**FAST ROAD & TRACK DAY BRAKE UPGRADES
BIG BRAKE KITS - RACE DISCS AND PADS**



JAPANESE CAR BRAKE APPLICATIONS

CarbonMetallic®

PADS

MAKE / YEAR	MODEL	APPLICATION	FRONT	REAR
HONDA				
93-00	Civic Coupe	Exc. EX & Si models	0273	0503
88-89	Civic CRX	Si	0273	0503
88-91	Civic CRX	DX	0273	0503
91- 01	Civic	EG9,EJ1,EJ8,ECT,ESi,VRi	0621	-
93-95	Civic Del Sol	S, Si w/o ABS	0273	-
99-	Civic	Type-R	0829	0537
99-	S2000	2.0 16v	0829	0537
02-	Integra	Type-R DC05	0639 / 0960	0537
91-05	NSX	3.0 / 3.2	0503	-
LEXUS				
00-05	IS300	3.0i V6	0619	0771
93-05	GS300	3.0i V8	0619	0771
98-00	GS400	4.0i V8	0619	0771
01-05	GS430	4.3i V8	0619	0771
96-97	LX450	4.5i V8	0502	-
02-09	SC430	4.3i V8	0619	0771
MAZDA				
85-96	RX-7	Coupe	0463	0482
94-00	MX5	Roadster	0635	0636
06-	MX5	Roadster	1179	1180
MITSUBISHI				
94-00	FTO	AKE	0530	0532
92-	"3000GT, GTO"	3.0 Twin Turbo	0460	0630
90-	Galant	VR4	0530	-
92-95	Evo III	AKE caliper	0530	-
96-08	EVO 5 - 9	Brembo caliper	1001 / 7781	0109
96-	EVO 4 - 9	AKE caliper	0530	0532
09-	EVO X	Brembo caliper	1001 / 7781	1368
92-96	3000 GTO	AKE caliper	0530	-
NISSAN				
94-01	200SX	2.0 Turbo	0460	-
90-94	300ZX	3.0 Twin Turbo	0460	0461
02-09	350Z	Brembo caliper	0639 / 0960	0109
09-	370Z		1346	1347
93-94	Skyline R32	GTR Brembo caliper	0639 / 0960	0109
95-98	Skyline R33	GTR Brembo Caliper	0639 / 0960	0109
99-	Skyline R34	GTR Brembo Caliper	0639 / 0960	0109
08-	Skyline R35	GTR Brembo Caliper	4362	7780
SUBARU				
98-	Impreza	Turbo	0460	0461
01-	Impreza WRX	Sti Brembo Caliper	1001 / 7781	0109
01-	Impreza	Prodrive P1	0460	0461
01-	Impreza	Prodrive P1 (upgrade Alcon)	7700	0461
02-	Forester	TOK Caliper	0929	-
02-	Impreza Non WRX / Sti	TOK Caliper	0929	-
02-	Outback	TOK Caliper	0929	-
12-	BRZ		0929	1124
TOYOTA				
83-87	Corolla	All AKE calipers	0282	-
94-98	Supra	Non Turbo	0619	0630
12-	GT86		0929	1124



JAPANESE CAR BRAKE APPLICATIONS

CarbonMetallic®

PADS FOR COMPETITORS KITS

MAKE / YEAR	COMPETITORS PART NO.	CALIPER/PISTONS	CALIPER TYPE	PFC PART NO.
AP Brake Kits				
	CP3215D50	4	CP5200	7767
	CP3345D44	4	CP5100	7740 / 7745
	CP3894D51	6	CP5555	7793 / 1247
	CP3894D54	6	CP5555	7790
	CP5070D51	6	CP5570	7793.17mm/1247
	CP5070D54	6	CP5555	7790.17mm
	CP6600D50	4	CP6600	7870
	CP6600D55	4	CP6600	7869
	CP7040D54	6	CP7040	7877
	CP7600D44	4	CP7600	7834
	CP7600D46	4	CP7600	Call for details
Brembo Brake Kits				
	107.5146.31	4	(A) Family Type	0592
	107.4865.80	4	(B) Family Type	7780
	107.5146.13	4	(C) Family Type	0592
	107.5146.13	4	(F) Family Type	0592
	107.9312.44	8	(G) Family Type	7743
	107.4865.80	4	(H) Family Type	7780
	207.9551.13	6	(J) Family Type	Call for details
	XA5.71.M2/XA5.71.M4	6	(M) Family Type	Call for details
	XA5.71.L2/107.9551.13	6	(N) Family Type	Call for details
	107.4865.80	4	(P) Family Type	7780
Alcon Brake Kits				
	PNF4498x603	4	Mono Bloc	7745
	PNF4497x607	6	Mono Bloc	7876
Stoptech Brake Kits				
		2	ST22	0109
		4	ST40	0447
		6	ST60	7793 / 1247
K-Sport / D2 Brake Kits				
		6	Front	7767
		8	Front	7790.17mm
		4	Rear	7745
		6	Rear	7745
Hi-Spec Brake Kits				
		2	Ultralite	0109 / 7824
		4	Ultralite	0109 / 7824
		2	Ultralite	0051
		4	Monster	7767
		6	Monster	7767
		4	Mega Monster	7793 / 1247
		6	Mega Monster	7793 / 1247
		4	R114-4 Narrow Pad	7740

cont...



JAPANESE CAR BRAKE APPLICATIONS

CarbonMetallic®

PADS FOR COMPETITORS KITS

MAKE / YEAR	COMPETITORS PART NO.	CALIPER/PISTONS	CALIPER TYPE	PFC PART NO.
Willwood				
	7912	4	Powerlite	7895
	7212	4	Dynalite w/ Bridgebolt	0421
	7520	6	GN III Caliper	7753
	7716	4	Billet Narrow Dynalite	7754
	7420	4/6	Superlite	7751

PAD COMPOUNDS

2011 Production Performance Friction Compounds - listed in the order of highest bite and torque

07 PFC's latest high bite and torque compound has been designed for the GT and rally market and has gained immediate favour with factory teams due to its unsurpassed performance. 07 has higher initial bite and higher average torque than any other PFC compound. 07 will have some friction rise with temperature and handle the most severe applications. The release and modulation characteristics are excellent as this compound is favoured for both tarmac and gravel surfaces. 07 gives very low disc wear despite its considerable performance and is still capable of similar wear to 01.

01 has high initial bite and torque with very little torque rise with temperature. It has less torque scatter at the end of the stop for improved modulation. 01 Compound has good disc conditioning properties with low wear. 01 Compound is one of PFC's most popular race compounds, and wins more World and National Championships annually than any other brake pad on the market. Recommended for a wide range of competition applications, both tarmac and gravel surfaces.

06 has been designed as an endurance / sprint compound and is very similar to PFC 01 for both bite and torque, with excellent release and control with very low wear and very easy on brake discs. 06 pads are an excellent alternative to other brands of endurance compounds but give a much higher performance. This compound works well in both motorsport and OE type calipers even when ABS systems are retained.

08 compound is one of PFC's newest and has gained immediate favour in extended Endurance Sportscar, and GT racing due to its performance in applications where smooth initial bite is a must. 08 has a slight friction rise with temperature, excellent release and modulation characteristics. Very low disc wear, similar to 01. Despite its considerable performance, 08 has the lowest wear rate of all PFC compounds and can easily match the wear characteristics of the other competitor's materials but with much higher bite.

97 Compound has less initial bite and average torque than 08. It has great modulation, a very flat torque curve, and enhanced release characteristics. 97 is recommended as a general-purpose pad for Club Racing and Track Day events. This compound also works well in the rear when a higher torque front pad is chosen but a very stable consistent low torque rear pad is required. 97 compound can produce higher levels of dust at elevated temperatures.

Z-Rated .10 / .11 - this compound has been designed for fast road / trackday applications. It gives more stopping power and increased fade resistance over the OE materials but retains the good qualities of the road pad i.e., low dusting and noise along with low wear rate.

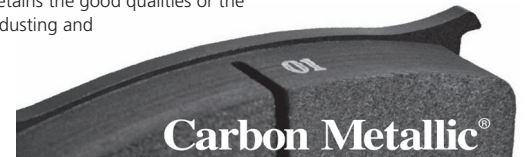

PAD PROFILES

PAD COMPOUNDS AVAILABLE

PART NUMBERING AS FOLLOWS:

Pad Shape **0031** Compound **.97** Total Thickness **.15** (mm)

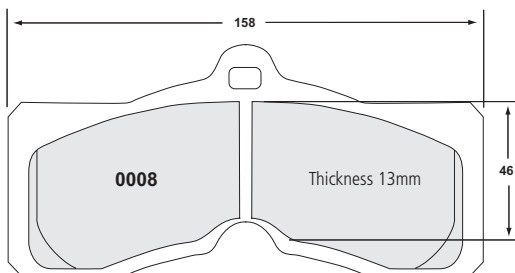

COMPOUNDS
.01 - .06

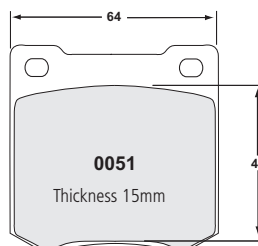

COMPOUNDS
.01

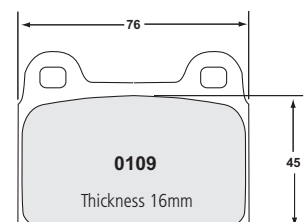

COMPOUNDS
.01 - .07 - Z-Rated



PAD PROFILES

CarbonMetallic®

PAD COMPOUNDS AVAILABLE **PART NUMBERING AS FOLLOWS:**
Pad Shape 0031 Compound .97 Total Thickness .15 (mm)

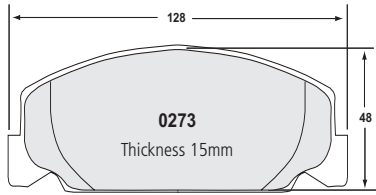

COMPOUNDS
Z-Rated

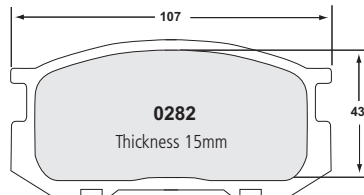

COMPOUNDS
Z-Rated

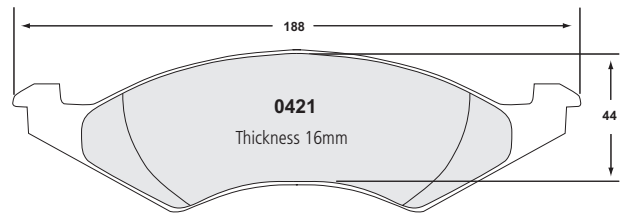

COMPOUNDS
Z-Rated

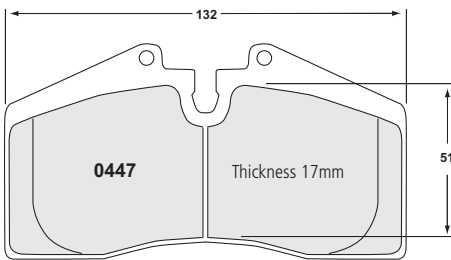

COMPOUNDS
.01 - .06 - Z-Rated

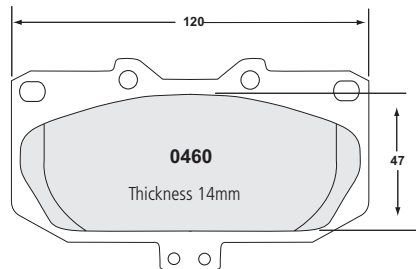

COMPOUNDS
.01 - .07

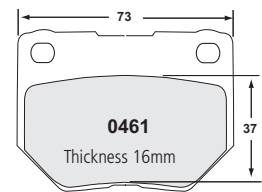

COMPOUNDS
.01 - .07 - Z-Rated

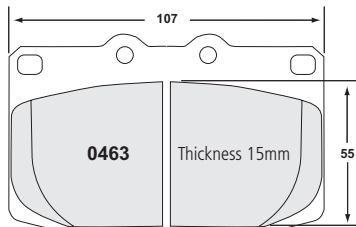

COMPOUNDS
.97

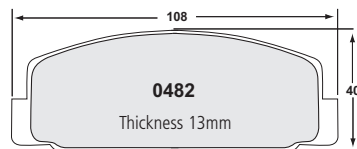

COMPOUNDS
Z-Rated

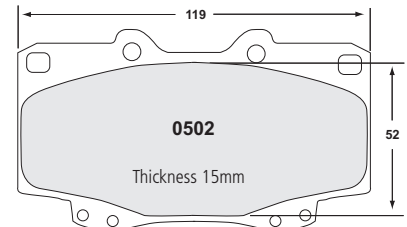

COMPOUNDS
Z-Rated

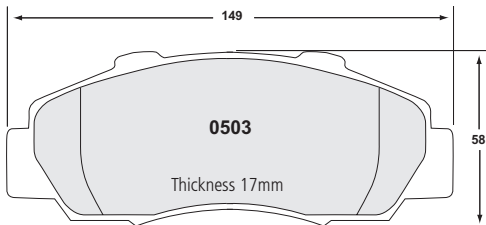

COMPOUNDS
.01 - .06

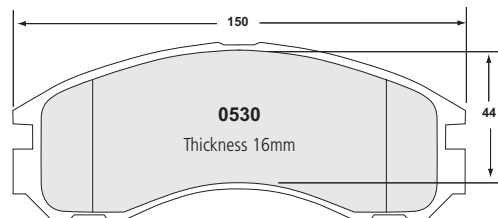

COMPOUNDS
.01 - .97

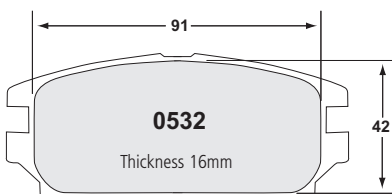

COMPOUNDS
.01 - .07 - .97

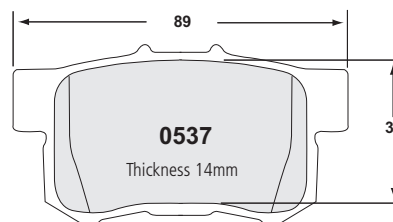

COMPOUNDS
.97



JAPANESE CAR BRAKE APPLICATIONS

CarbonMetallic®

PAD PROFILES

PAD COMPOUNDS AVAILABLE

PART NUMBERING AS FOLLOWS:

Pad Shape **0031** Compound **.97** Total Thickness **.15** (mm)

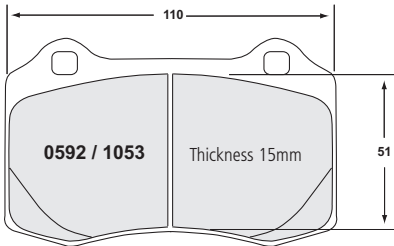

COMPOUNDS
.01 - .97 - Z-Rated

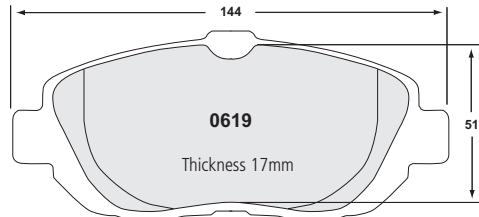

COMPOUNDS
Z-Rated

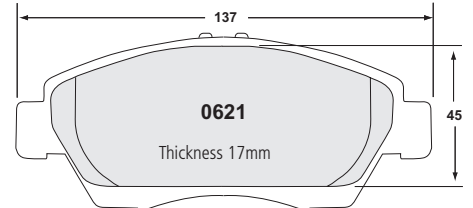

COMPOUNDS
.97 - 07

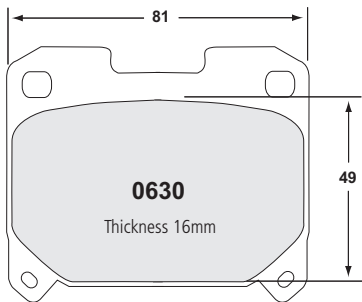

COMPOUNDS
Z-Rated

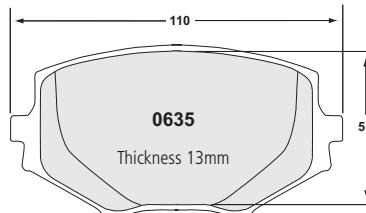

COMPOUNDS
.97

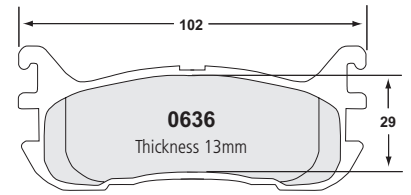

COMPOUNDS
.97

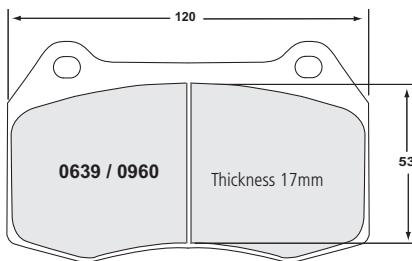

COMPOUNDS
.01 - .05

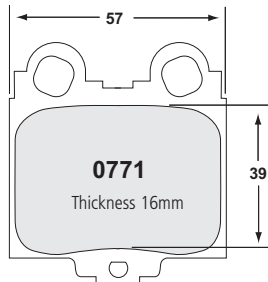

COMPOUNDS
.97 - Z-Rated

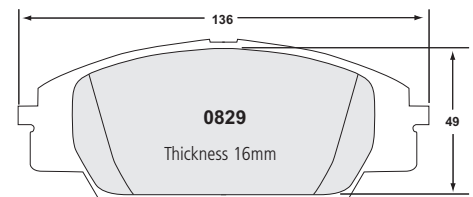

COMPOUNDS
.97

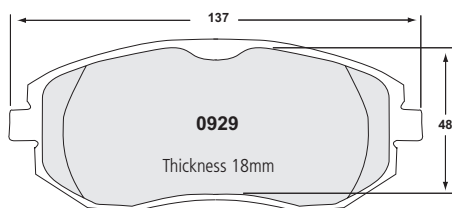

COMPOUNDS
Z-Rated

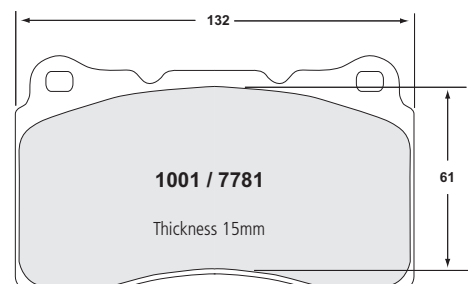

COMPOUNDS
.01 - .05 - .07 - .97 - Z-Rated



PAD PROFILES

CarbonMetallic®

PAD COMPOUNDS AVAILABLE

PART NUMBERING AS FOLLOWS:

Pad Shape **0031** Compound **.97** Total Thickness **.15**(mm)

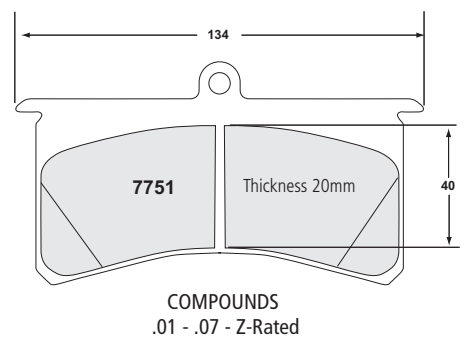
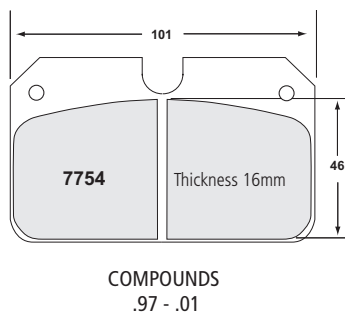
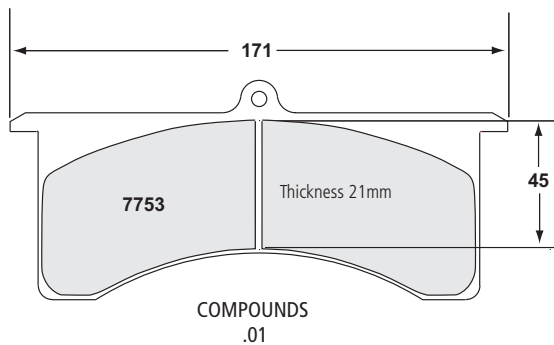
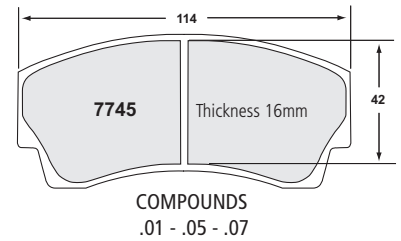
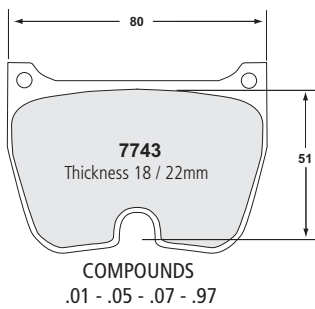
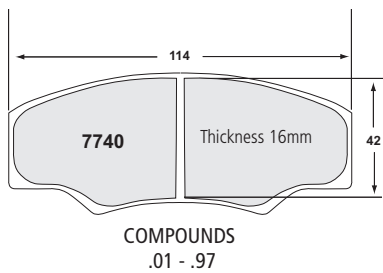
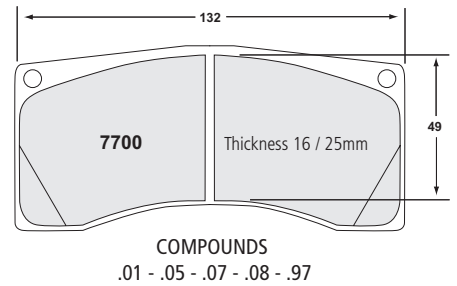
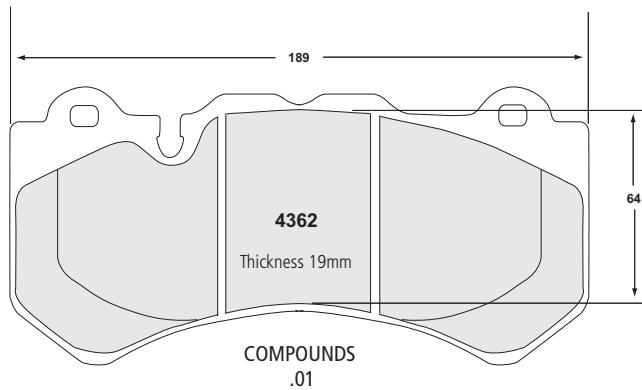
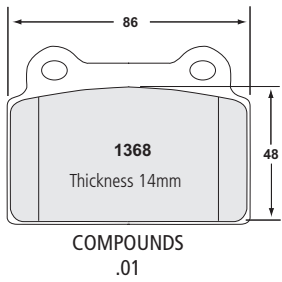
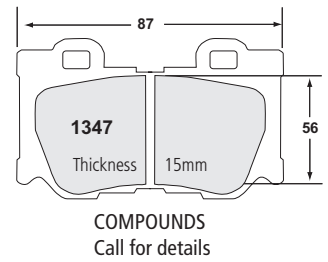
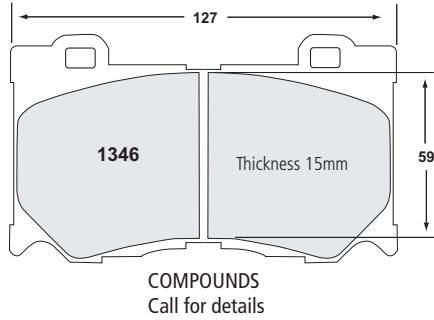
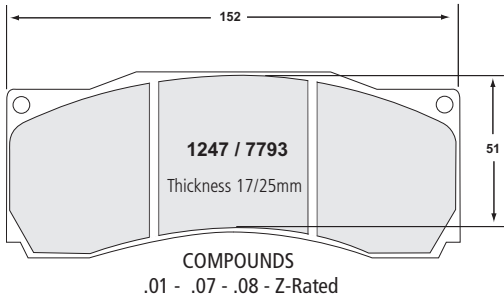



JAPANESE CAR BRAKE APPLICATIONS

CarbonMetallic®

PAD PROFILES

PAD COMPOUNDS AVAILABLE

PART NUMBERING AS FOLLOWS:

Pad Shape **0031** Compound **.97** Total Thickness **.15** (mm)

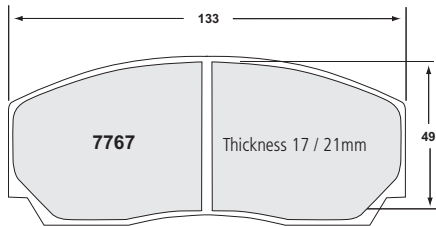

7767 Thickness 17 / 21mm
COMPOUNDS
.01 - .05 - .07 - .08 - .97 - Z-Rated

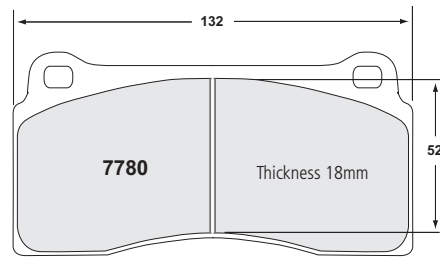

7780 Thickness 18mm
COMPOUNDS
.01 - .05 - .07 - .97 - Z-Rated

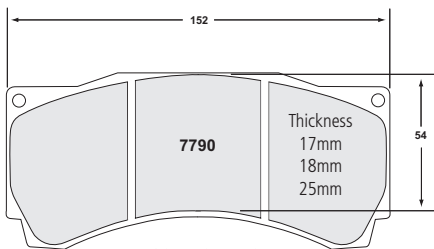

7790 Thickness 17mm, 18mm, 25mm
COMPOUNDS
.01 - .05 - .07 - .97 - Z-Rated

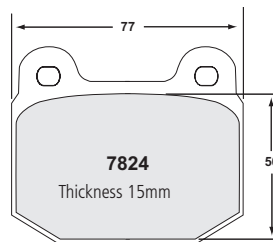

7824 Thickness 15mm
COMPOUNDS
.01 - .08 - .97

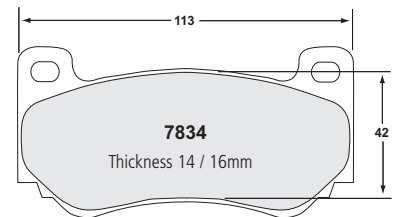

7834 Thickness 14 / 16mm
COMPOUNDS
.01

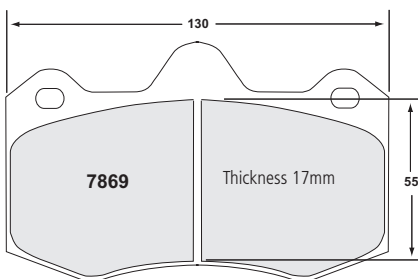

7869 Thickness 17mm
COMPOUNDS
.01

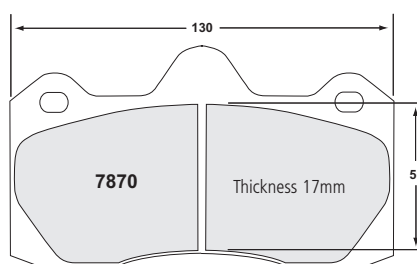

7870 Thickness 17mm
COMPOUNDS
.97

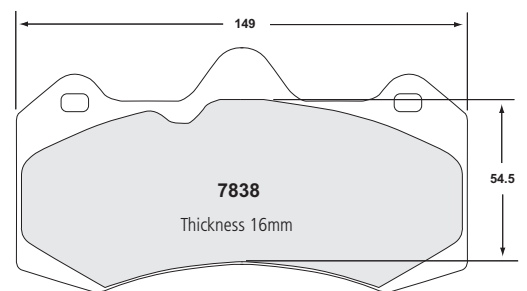

7838 Thickness 16mm
COMPOUNDS
.01

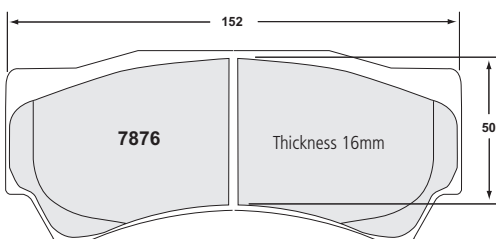

7876 Thickness 16mm
COMPOUNDS
.01

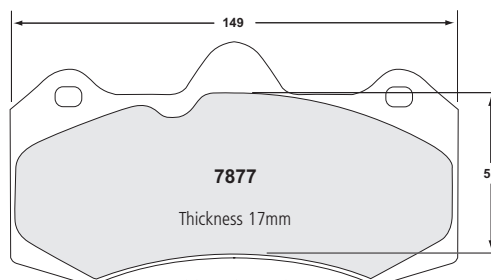

7877 Thickness 17mm
COMPOUNDS
.97 - Z-Rated

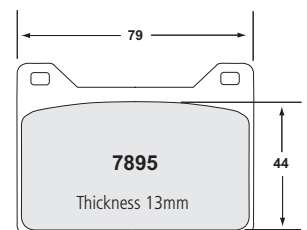

7895 Thickness 13mm
COMPOUNDS
.97



JAPANESE CAR BRAKE APPLICATIONS

CarbonMetallic®

2 PIECE DISC UPGRADES FOR STANDARD OE CALIPERS

APPLICATION	MOUNTING	PART NO.	
		DISC / HAT ASSEMBLY	REPLACEMENT DISC FOR ASSEMBLY
HONDA			
S2000 - disc assembly (Dimpled)	Front	300.040.85/86	300.25.0048.43/44
MAZDA			
MX5 2006- hat and floating disc assembly (Dimpled)	Front	290.450.85/86	290.22.0051.85/86
MITSUBISHI			
EVO 5 - 9 1997-08 - hat and floating disc assembly (Dimpled)	Front	319.044.87/88	319.32.0060.87/88
EVO 5 - 9 1997-08 - hat and floating disc assembly (Slotted)	Front	319.044.67/68	319.32.0060.67/68
EVO Evo 5 - 9 1997-08 - hat and floating disc assembly (Dimpled)	Rear	300.058.85/86	300.22.0046.43/44
EVO X 2008 - hat and floating disc assembly (Dimpled V2 drive system)	Front	348.044.85/86	348.32.0060.85/86
NISSAN			
350Z (Brembo caliper) 2003 - hat and floating disc assembly (Dimpled)	Front	324.049.87/88	324.30.0053.87/88
Skyline R32, R33, R34 GTR (Brembo Caliper) 1993-05	Front	324.054.87/88	324.30.0053.87/88
GT-R35 - 2008- 2011 hat and floating disc assembly (Dimpled V2 drive system)	Front	376.049.85/86	376.34.0064.43/44
GT-R35 - 2008- 2011 hat and floating disc assembly (Dimpled V2 drive system)	Rear	381.062.85/86	381.30.0053.85/86
GT-R35 - 2008- 2011 hat and floating disc assembly (Slotted V2 drive system)	Front	376.046.67/68	376.34.0064.45/46
GT-R35 - 2011- 405mm Disc upgrade kit (Slotted V2 drive system)	Front	405.049.67/68	405.34.0065.67/68
GTR-R35 - 2011- hat and floating disc assembly Slotted	Rear	381.062.67/68	381.30.0053.67/68
SUBARU			
Impreza WRX Non- Brembo 4 pot Caliper - 99 - 01 (Slotted V2 drive system)	Front	293.057.67/68	293.25.0047. 67/68
Impreza WRX STi, Brembo Caliper - 2001 - (Dimpled)	Front	326.053.87/88	326.30.0061.87/88

REPLACEMENT BRAKE DISCS FOR AP KITS

OE PART NO.	PFC PART NO.	POPULAR APPLICATIONS	ALL UNITS IN MM					
			DIAM	THICKNESS	PAD SWEEP AREA	DISC MTG PCD	DISC MTG HOLE	NO. BOLT HOLES
CP3580-102/103	295.28.0051.03/04	HONDA, NISSAN	295	28	51	177.8	6.4	12
CP3580-2572/2573	304.28.0049.01/02	AP RALLY APPLICATIONS	304	28	51	177.8	6.4	12
CP3580-2899/2898	330.28.0049.03/04	HONDA, MAZDA, MITSUBISHI, SUBARU	330	28	51	203	6.4	12
CP3581-767/766	332.32.0056.03/04	MITSUBISHI EVO	332	32	57	203	6.4	12
CP3718-1069/1068	362.32.0055.03/04	MITSUBISHI EVO	362	32	56	228	6.4	12
CP3718-1031/1030	378.32.0053.03/04	VARIOUS	378	32	55	239	11.6x9.3	12

*These discs utilise the AP bell and mounting equipment as a direct replacement for the AP disc



JAPANESE CAR BRAKE APPLICATIONS

BRAKE KITS

APPLICATION	YEAR	F/R	DIAM	CALIPER	PISTONS	CALIPER TYPE	PART NO.	PART NO.
HONDA								
Integra Type R	1997- 2001	Front	295mm	ZR34	4	MONOBLOC	3400.0002	3400.0022
NSX	1991- 2005	Front	355mm	ZR31	4	MONOBLOC	3100.0012	3100.0212
NSX	1991- 2005	Rear	355mm	ZR31	4	MONOBLOC	0031.0005	0031.0025
LEXUS								
ISF	2008 >	Front	355mm	ZR31	4	MONOBLOC	3100.0009	3100.0029
ISF	2008 >	Rear	371mm	ZR31	4	MONOBLOC	0031.0004	0031.0024
MITSUBISHI								
Lancer EVO 5 - 8	2003 - 2006	Front	362mm	ZR31	4	MONOBLOC	3100.0007	3100.0027
Lancer EVO 5 - 9	2003 - 2006	Rear	330mm	ZR29	2	2-PIECE	1363.0001	1363.0002
Lancer EVO 10	2007 >	Front	362mm	ZR31	4	MONOBLOC	3100.0001	3100.0021
Lancer EVO 10	2007 >	Rear	330mm	ZR29	2	2-PIECE	0029.0001	0029.0021
NISSAN								
350 Z	2003 - 2008	Front	355mm	ZR31	4	MONOBLOC	3100.0010	3100.0210
350 Z	2003 - 2008	Rear	321mm	ZR29	2	2-PIECE	0029.0005	0029.0025
SUBARU								
LEGACY	2010 >	Front	355mm	ZR44	4	MONOBLOC	1444.0001	1444.0002
LEGACY	2010 >	Rear	330mm	ZR29	2	2-PIECE	1445.0001	1445.0002
WRX	2006 -2007	Front	355mm	ZR31	4	MONOBLOC	1444.0001	1444.0002
WRX	2006 -2007	Front	323mm	ZR44	4	MONOBLOC	1446.0001	1446.0002
WRX STi	2004 >	Front	323mm	ZR44	4	MONOBLOC	1446.0001	1446.0002
WRX STi	2004 >	Front	355mm	ZR31	4	MONOBLOC	1444.0001	1444.0002
WRX STi	2004 -2007	Rear	330mm	ZR29	2	2-PIECE	1445.0001	1445.0002

PFC V2 DIRECT DRIVE SYSTEM

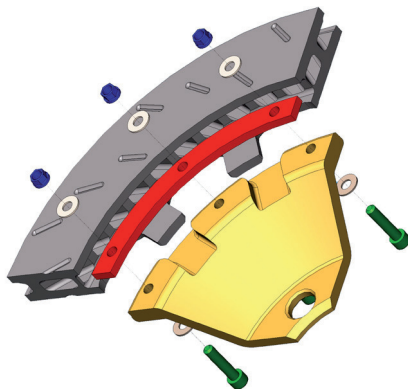



JAPANESE CAR BRAKE APPLICATIONS

NISSAN GT-R35 SKYLINE

Carbon Metallic®

Direct Drive V2, two-piece floating, front and rear brake disc assemblies to replace original equipment discs and uprated Carbon Metallic brake pads.

This package has been designed to directly replace the original Equipment fitted on the GTR35. These discs do not have any drilled holes which have been associated with the propagation of cracks. Both front and rear discs are mounted to the bells using our own Direct Drive V2 mounting system which also incorporates an anti rattle device to eliminate the noise that can be associated with floating disc assemblies.

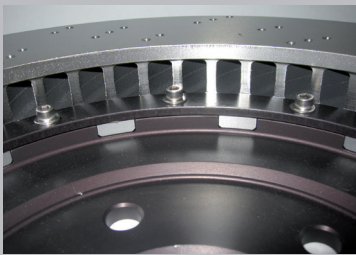

Front disc showing mounting system



Rear disc with integral drum

MITSUBISHI EVOLUTION X BIG BRAKE KITS



PFC Direct Drive System

KIT INCLUDES

- Forged Multipad Monobloc Calipers
- Direct Drive V2 Molybdenum Alloy Discs
- Carbon Metallic® Pads
- Custom Engineered for the Street / Trackday
- Genuine Race Technology
- Custom Colours
- Stainless Steel Braided Hoses
- Caliper Mounting Brackets and Fittings

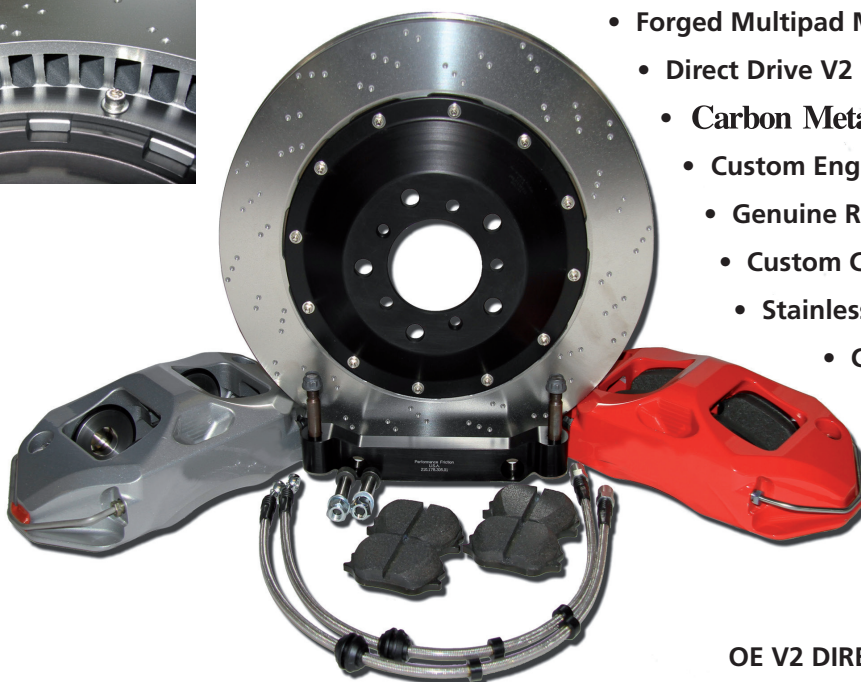

OE V2 DIRECT DRIVE DISCS ALSO AVAILABLE



HOW TO FIND US

Our European Headquarters located at Banbury in Oxfordshire is extremely well serviced by road, rail and air transport.

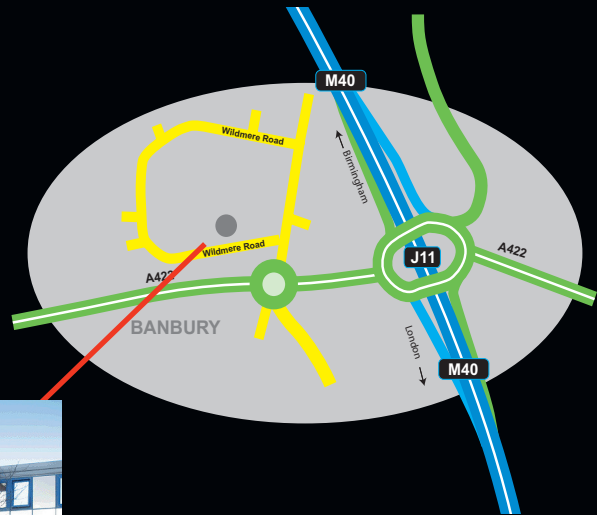

Performance Friction Europe

Carbon Metallic House, Wildmere Road,
Banbury, Oxon OX16 3LU
United Kingdom

Tel: +44(0)1295 221020 Fax: +44(0)1295 279711

uksales@pfcbrakes.com
www.pfcbrakes.com